

Note prior to placing order

Please do not use our products under conditions or environments not described in this catalog. Even under the conditions or environments described in this catalog, if you want to use our products for applications requiring high reliability (These include, but are not limited to, nuclear power control equipment, railroad equipment, aviation equipment, vehicle equipment, combustion equipment, medical equipment, entertainment equipment, and disaster prevention equipment), be sure to contact our point of contact beforehand.

The details of warranty shall be as per the descriptions in this document and we shall not be liable for any damage on you resulting from the use of any equipment or device (including control systems) which is not in accordance with this document (hereinafter referred to as "use in violation"). In the case where you resell our products, we shall not be liable for any damage on a third party resulting from use in violation by the third party, and even if we make payment to the third party in connection with such use in violation regardless of the name by which such payment may be called, we may demand the whole amount thereof from you.

〈Warranty Period〉

The warranty period is one year from the date of delivery. The warranty is only applicable to the product itself, not applicable to consumable products such as batteries and etc.

〈Warranty Coverage〉

If any malfunctions should occur due to our fault, NIDEC COMPONENTS warrants any part of our product within one year from the date of delivery by repair or replacement at free of charge. However, warranty is not applicable if the causes of defect should result from the following conditions:

- Failure or damages caused by inappropriate use, inappropriate conditions, and inappropriate handling.
- Failure or damages caused by inappropriate modifications, adjustment, or repair.
- Failure or damage caused by technically and Scientifically unpredictable factors.
- Failure or damage caused by natural disaster, fire or unavoidable factors.

JOYSTICK ENCODERS **CJ25**

FEATURES

- Multi-function device ... Joystick, optical encoder, and push switch functions in one package.
- Suitable size for panels. Smooth operational feel.
- Long life ... Joystick 500K cycles, encoder & switch 1M cycles
- RoHS compliant



APPLICATIONS

Operation panels for ;

- Medical device
- Broadcast equipment
- Surveillance camera etc.

PART NUMBER DESIGNATION

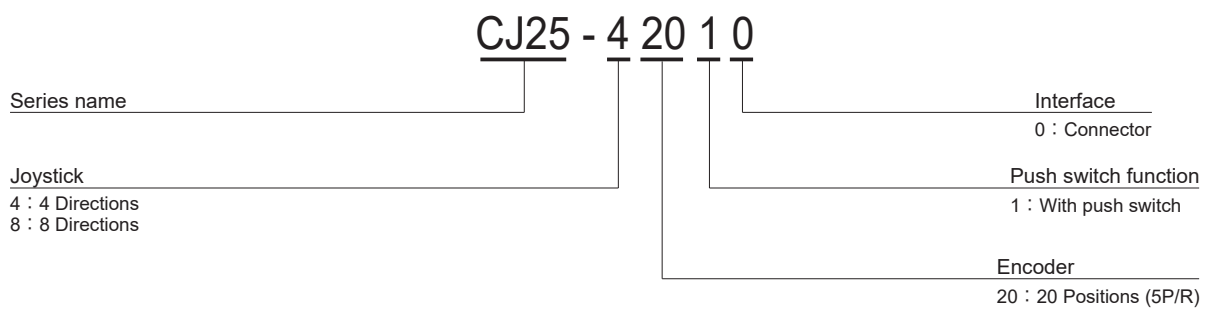

LIST OF PART NUMBERS

Part number	Joystick	Encoder	Push switch function	Interface
CJ25-42010	4 directions	20 Positions (5P/R)	With push switch	Connector
CJ25-82010	8 directions			

CJ25

JOYSTICK ENCODERS

STANDARD SPECIFICATIONS

Electrical characteristics

Encoder

Input voltage	DC5 V \pm 5 %
Input current	20mA maximum at 5V
Output wave form	Incremental signal (Square wave)
Pulses Per Rotation	5P/R
Maximum frequencies response	10Hz
Output	Open collector, Pull-up resistor 2.2K Ω
Output Code	2-Bit, Channel A/B, Phase difference 90°
Output Signal	High : 3.8V minimum Low : 0.4V maximum
Output Sink Current	6 mA maximum

Joystick

Input current	5mA maximum at 5V
Output Code	2-Bit (X, Y)
Output Signal	Neutral : 2.5 \pm 0.5V High : 4.5V minimum Low : 0.5V maximum

Switch

Rating	DC5V, 10mA
Contact Resistance	10 Ω maximum
Contact Bouncing	Switching : 4ms make Non-switching : 10ms break

Mechanical characteristics

Mounting Torque	1.17N · m maximum (12kgf · cm maximum)
Actuator Strength	19.6N maximum (2kg maximum)
Max. Shaft Pull-out Strength	98N maximum (10kg maximum)
Max. Shaft Push-out Strength	98N maximum (10kg maximum)

Encoder

Click Torque	9.8 \pm 4.9mN · m (100 \pm 50gf · cm)
Clicks Per Rotation	20
Rotational Life	1 million cycles

Joystick

Angle of Throw	All directions 9 \pm 2°
Operating Force	X, Y 1.47 \pm 0.74N (150 \pm 75gf)
Joystick Life	500,000 actuation each in directions (X, Y)

Switch

Operating Force	3.43 \pm 1.47N (350 \pm 150gf)
Stroke	0.5 \pm 0.2mm
Switching Life	1 million cycles

Environmental characteristics

Operating Temp. Range	0°C ~ + 50°C
Storage Temp. Range	-20 ~ 80°C

RELIABILITY TEST

Test item		Test conditions	
Vibration	Power OFF	Amplitude : 1.52mm or 98.1m/s ² (10G) whichever is smaller. 10 ~ 500Hz excursion 15 min/cycle, 8 cycles each for X, Z, directions.	
Shock	Power OFF	3 times each in directions (X, Z) at 490m/s ² (50G), 11ms.	
High temperature exposure	Power OFF	80 °C 96 h	(To be measured after leaving samples for 1 h at normal temperature and humidity after the test.)
	Power ON	50 °C 96 h	
Low temperature exposure	Power OFF	- 20 °C 96 h	
	Power ON	0 °C 96 h	
Humidity	Power OFF	To be measured after wiping out moisture and leaving samples for 1 h at normal temperature and humidity after the test.	
Thermal shock	Power OFF	To be done 10 cycles with the following condition (To be measured after leaving samples for 1 h at normal temperature and humidity after the test.) 80 °C 0.5 h, - 20 °C 0.5 h	

CJ25 JOYSTICK ENCODERS

OUTLINE DIMENSIONS

Unless otherwise specified, tolerance: ± 0.4 (Unit: mm)

PIN ASSIGNMENT

Pin No.	Function
1	Joystick "X"
2	Joystick "Y"
3	Power "+5V"
4	Output "A"
5	Output "B"
6	Switch
7	Switch
8	GND

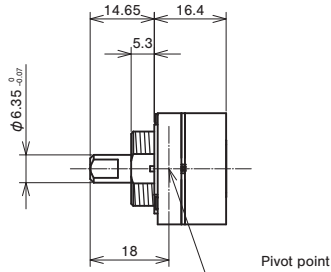

<Accessories>

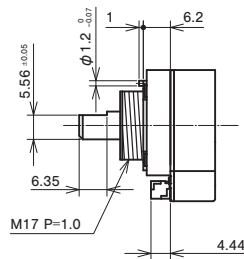
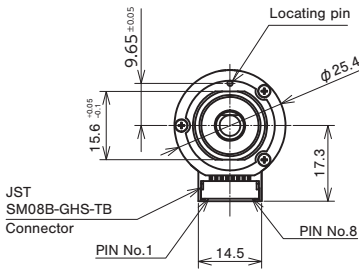
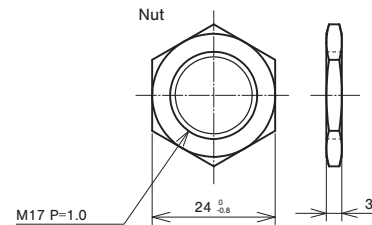

<Panel cut-out dimensions>

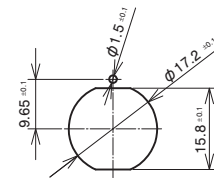

OUTPUT

JOYSTICK

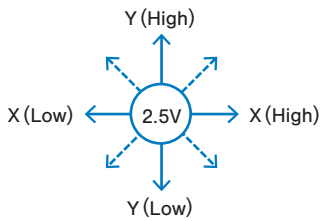

"Y (High)" defined by locating pin.

ENCODER Output Waveform

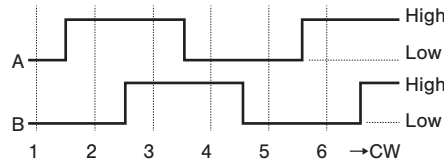

Position number: 1~6... (Clockwise rotation)

Position	Output	A	B
1			
2		●	
3		●	●
4			●

● =High
blank=Low

※ Code repeats every 4 positions.

SWITCH

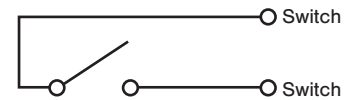

OPTION (Wire harnesses)

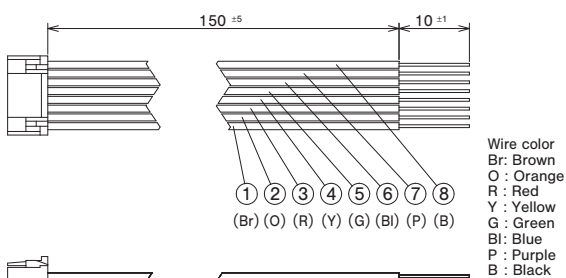

Optional wire harnesses are available upon request.

OUTPUT CIRCUITRY AND RECEIVING CIRCUITRY

