

# For better use of our Catalog

---

## ⟨For specifications⟩

Specifications in this product catalog are subject to change without prior notice. Detailed specifications are omitted for some of the products due to limited space. Please inquire and ask for individual specification sheets when ordering.

## ⟨Information⟩

Our product catalog consists of two volumes.

This catalog, the first volume, carries product information on switches, trimmers, attenuators, circuit protectors,

Please see the second volume for other products such as sensors and motors.

The switches described in this catalog include DIP switches and Operating switches.

Concerning Operating switches such as order to be made products and standard products, there is a common annotation related to switches at last half catalog. Please refer it.

For other products, in each product catalog  logo or a description to point out order to be made products on each item at the catalog.

If there is no indication, it is a standard products.

## Note prior to placing order

---

Please do not use our products under conditions or environments not described in this catalog. Even under the conditions or environments described in this catalog, if you want to use our products for applications requiring high reliability (These include, but are not limited to, nuclear power control equipment, railroad equipment, aviation equipment, vehicle equipment, combustion equipment, medical equipment, entertainment equipment, and disaster prevention equipment), be sure to contact our point of contact beforehand.

The details of warranty shall be as per the descriptions in this document and we shall not be liable for any damage on you resulting from the use of any equipment or device (including control systems) which is not in accordance with this document (hereinafter referred to as "use in violation"). In the case where you resell our products, we shall not be liable for any damage on a third party resulting from use in violation by the third party, and even if we make payment to the third party in connection with such use in violation regardless of the name by which such payment may be called, we may demand the whole amount thereof from you.

### 〈Warranty Period〉

The warranty period is one year from the date of delivery. The warranty is only applicable to the product itself, not applicable to consumable products such as batteries and etc.

### 〈Warranty Coverage〉

If any malfunctions should occur due to our fault, NIDEC COMPONENTS warrants any part of our product within one year from the date of delivery by repair or replacement at free of charge. However, warranty is not applicable if the causes of defect should result from the following conditions:

- Failure or damages caused by inappropriate use, inappropriate conditions, and inappropriate handling.
- Failure or damages caused by inappropriate modifications, adjustment, or repair.
- Failure or damage caused by technically and Scientifically unpredictable factors.
- Failure or damage caused by natural disaster, fire or unavoidable factors.

# OUTLINE

## TRIMMER POTENTIOMETERS

---

### ■ Cermet trimmer potentiometers

NIDEC COMPONENTS brings extensive thick film technology, lead connection technology, contact technology, sealing technology, wiper technology, and others to its lineup of cermet trimmer potentiometers.

Keeping pace with advances in information equipment, IC, LSI, microcomputer control and other advances, increased functions, and miniaturization of equipment, NIDEC COMPONENTS cermet trimmer potentiometers come in an increasing number of variations from through hole pin types, to surface mount and chip types, responding to the needs of a wide range of equipment.

Cermet trimmer potentiometers have the following characteristics in general:

- Wide resistance range
- Excellent environment characteristics
- Essentially infinite resolution

At the same time, the use of glass in thick film resistor devices means that wiper noise can occur easily. However, NIDEC COMPONENTS products minimize this noise using multi-contact wiper technology.

NIDEC COMPONENTS cermet trimmer potentiometers cover a wide range of manufacturing conditions and use environments, with sealed construction for higher reliability.

Each basic configuration has the following features.

### ■ SURFACE MOUNT TYPE

NIDEC COMPONENTS provides an extremely thin and compact trimmer on your SM board. O-ring sealing and high temperature resistance allow to handle this component with the same soldering and cleaning methods of other SMD's.

### ■ SINGLE TURN TYPE

The wiper is directly attached to the rotor and travels on a circular resistance element. Despite some difficulty in fine adjustment this type is being widely used because of its simple construction and low price.

### ■ RECTANGULAR MULTITURN TYPE

The lead screw actuates the wiper to travel in a linear motion on a straight resistive track.

This type provides fine adjustment and is used for high precision equipment.

### ■ SQUARE MULTITURN TYPE

The adjustment screw actuates a worm gear which turns a wiper assembly on a circular resistive element.

This type allows fine adjustment and offers advantages over the rectangular type with respect to the board space, mounting location and the direction of adjustment.

# GLOSSARY (CERMET TRIMMERS)

## TRIMMER POTENTIOMETERS

---

### ● Overlap

Overlap refers to the end portion of the cermet device. Electrodes are printed on a ceramic base and then baked. The cermet resistor is printed over this portion and baked.

### ● Rotational life test

This is a test to check the life of the cermet trimmer when the product is rotated near the life expectancy.

Test conditions:

The shaft is turned back and forth 200 cycles (or 100 cycles), with no load at 90 % of the electrical effective angle or electrical adjustment number of turns, and change in resistance and mechanical damage are checked.

Specifications:

The change in total resistance value varies by model (See main text). No mechanical damage is permitted.

※ In accordance with MIL-R-22097 4.6.18

### ● Stop strength

For single turn trimmer potentiometers with mechanical stops, this is the maximum applicable rotational torque which will not break the stops. It is specified as "XXX mN·m, minimum".

### ● Operating torque

This is the torque necessary to turn the rotor or shaft.

### ● Mechanical angle

This is the rotation angle that the rotor can be turned from the stopper on one end to the stopper on the other end. For multiturn trimmer potentiometers this is the maximum number of turns possible by the adjustment screw.

### ● Clutch action

Multiturn trimmer potentiometers turn a rotor gear by turning the adjustment shaft, and a screw is used to transmit this rotation. A clutch mechanism is generally used in place of a stopper at the end of the rotational travel.

NIDEC COMPONENTS products use a blade spring or a plastic spring, with the construction differing for different models.

Generally, a clutch spring noise is heard at the end of the rotation, but there is no specification on the noise degree.

### ● Nominal resistance value

Resistance value between terminal 1 and terminal 3.

### ● Shear (Adhesion)

This test is to evaluate if any damages like electrode stripping, breaks, or cracks occur on a SMD component soldered to the printed circuit board due to stress from the flank.

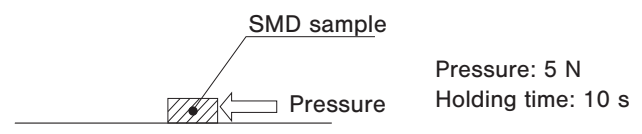

### ● Maximum input voltage

This is the maximum voltage that can be applied at all resistance levels between terminal 1 and terminal 3.

The maximum input voltage varies depending on the resistance value.

### ● Maximum wiper current

This is the maximum current that can be allowed to flow through the wiper. The maximum wiper current varies depending on the resistance value.

### ● Cermet

Cermet resistors are called thick-film cermets, and are made by baking ceramics, glass, and precious metal particles at high temperatures. The word cermet was derived by abbreviating ceramic metal. Our cermets have superior temperature characteristics, heat resistance, and wide resistance ranges and are of the glass RuO<sub>2</sub> variety.

### ● End resistance

The resistance measured between the wiper and the corresponding terminals when the wiper is at the end of its mechanical travel.

# GLOSSARY (CERMET TRIMMERS)

## TRIMMER POTENTIOMETERS

### ● Contact resistance (Rc)

This is the resistance between the wiper and the resistor after setting and is calculated by the following formula.

$$R_c (\%) = \frac{(R_{12} + R_{23}) - R_{13}}{2R_{13}} \times 100$$

Contact resistance occurs due to the oxidation of wiper's metallic surface and resistance from the glass on the surface of the cermet or from the micro distribution of the cermet device.

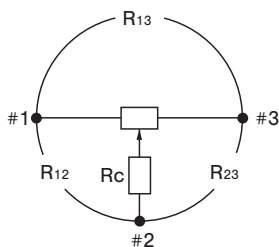

### ● Contact resistance variation (CRV)

Contact resistance variation is the maximum momentary change in contact resistance that occurs when the wiper is moved from one location to another location. The larger this change, the more difficult it is to set the trimmer potentiometer and the more unstable the long term setting will be.

#### a. Measuring circuit

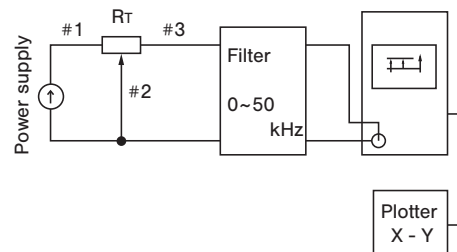

#### b. Measuring point

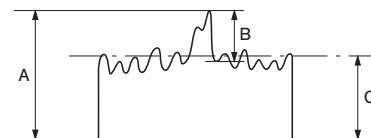

CRV measured waveform

- CRV waveform
- DC peak value (%)
- AC component peak (part guaranteed by us)
- Peak value (%)
- DC component average value  $\hat{=}$  Contact resistance

Measurement of the C.R.V. is defined over 90 % of the electrical effective angle or electrical adjustment revolutions and does not include the electrically unstable area near the ends (the portion where the electrodes and resistor overlaps).

# GLOSSARY (CERMET TRIMMERS) TRIMMER POTENTIOMETERS

## ● Setting stability

This shows the stability of the trimmer potentiometer after the wiper is set in an arbitrary position. Stability can be divided into voltage setting stability (S.S.) and resistance setting stability.

$$\text{S.S. (\%)} = \left\{ \left( \frac{V}{E} \right) \text{ after test} - \left( \frac{V}{E} \right) \text{ before test} \right\} \times 100$$

## <Resistance setting stability>

When used as a rheostat as in the Fig. 2, the change in contact resistance of the wiper changes the set value.

Here the setting stability is calculated from the resistance between terminals:

$$\Delta \frac{R_{12}}{R_{13}} (\%) = \left\{ \left( \frac{R_{12}}{R_{13}} \right) \text{ after test} - \left( \frac{R_{12}}{R_{13}} \right) \text{ before test} \right\} \times 100$$

$$\Delta \frac{R_{23}}{R_{13}} (\%) = \left\{ \left( \frac{R_{23}}{R_{13}} \right) \text{ after test} - \left( \frac{R_{23}}{R_{13}} \right) \text{ before test} \right\} \times 100$$

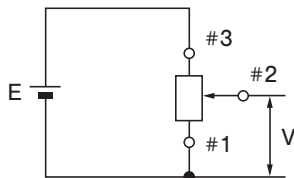

Fig.1

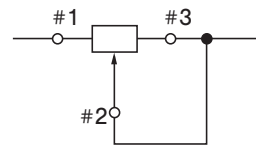

Fig.2

## ● Insulation resistance

This is the resistance between the housing, rotor, shaft, and other non-terminal parts and the terminal when a designated D.C. voltage is applied.

## ● Total resistance

This is the resistance between #1 and #3 terminals. The usual unit is ohm, with a plus or minus percent attached to show tolerance. Measurement is performed with the wiper set at the #1 or #3 terminal electrode to minimize the affect of the wiper on measurement accuracy.

## <Voltage setting stability>

When used as a potentiometer as in the Fig. 1, current does not flow through the wiper, so the change in contact resistance does not affect the setting stability. The following formula applies.

## ● Substrate bending

This test is to evaluate durability against stress due to distortion of the print circuit board at the time or after SMD is mounted.

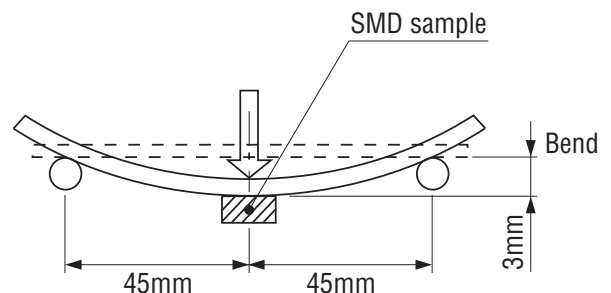

# GLOSSARY (CERMET TRIMMERS)

## TRIMMER POTENTIOMETERS

### ● Dielectric strength

This is the ability to withstand the application of voltage between the housing, rotor, shaft, and other external conducting parts and the terminal without exceeding the specified leakage current leakage.

### ● Power rating

The power rating is the maximum power that can be applied over all the resistance element (from terminal 1 to terminal 3) with a continuous load at the operating ambient temperature.

Mathematically, it follows the formula below (Fig.1):

Because the applied power creates heat in the resistor, the rated power is determined by the heat released and the ability of the components to withstand the heat. Thus, the rated power changes with the ambient temperature. (Fig. 2)

$$P = I^2R \text{ or } P = \frac{E^2}{R}$$

- P : Power (W)
- I : Current (A)
- E : Voltage (V)
- R : Resistance ( $\Omega$ )

Fig.1

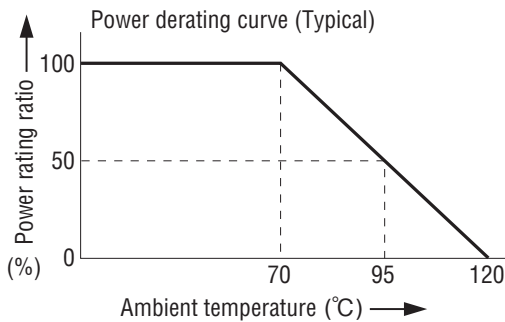

Fig.2

### ● Resistance temperature characteristic

The resistance temperature characteristic shows the rate of change in the total resistance when the ambient temperature changes. The unit of measure for the resistance temperature coefficient is  $10^{-6}/^{\circ}\text{C}$ .

$$\text{Temperature coefficient } (10^{-6}/^{\circ}\text{C}) = \frac{R - R_0}{R_0} \times \frac{1}{t - t_0}$$

R : Measured resistance at t  $^{\circ}\text{C}$  ( $\Omega$ )

R<sub>0</sub> : Measured resistance at t<sub>0</sub>  $^{\circ}\text{C}$  ( $\Omega$ )

t : Measured temperature in test room ( $^{\circ}\text{C}$ )

t<sub>0</sub> : Measured reference temperature ( $^{\circ}\text{C}$ )

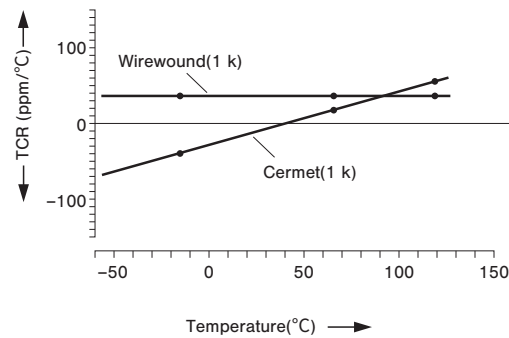

The resistance temperature characteristic is highly affected by the resistor material of the trimmer potentiometer and the physical structure.

For wirewound trimmer potentiometers, the rate of change is usually constant at around  $\pm 50$  ppm/ $^{\circ}\text{C}$ . For cermet trimmer potentiometers, the resistance temperature coefficient is temperature dependent. In other words, the rate of resistance value changes as the ambient temperature changes. Thus, the change in resistance experienced when the ambient temperature changed from  $25^{\circ}\text{C}$  to  $35^{\circ}\text{C}$  would be different from that experienced when the ambient temperature changed from  $100^{\circ}\text{C}$  to  $110^{\circ}\text{C}$ .

# GLOSSARY (CERMET TRIMMERS)

## TRIMMER POTENTIOMETERS

### ● Resistance code

NIDEC COMPONENTS products, with the exception of the ST-32 indicate resistance values with a three digit code.

### ● Trimmer potentiometers

Also referred to as preset variable resistors, trimmer potentiometers differ from normal volume controls and are used to adjust the irregularities between parts in equipment and to allow arbitrary settings and are seldom moved after their initial setting.

### ● Soldering heat

This is to evaluate heat resistance in soldering components.

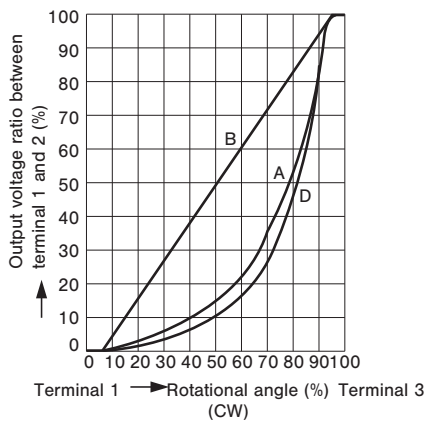

Fig.1

### ● Resistance law

These characteristics can be divided into four types based on the change in output voltage ratio between terminals 1 and 2 or 2 and 3, when a voltage is applied between terminals 1 and 3 (below the rated voltage) and the adjustment shaft is turned CW or CCW.

A characteristic: Change logarithmic as shown in

Fig. 1, A

B characteristic: Change linearly as shown in Fig. 1, B

C characteristic: Change logarithmic as shown in

Fig. 2, C

D characteristic: Change logarithmic as shown in

Fig. 1, D

※ Our cermet trimmers have B characteristic.

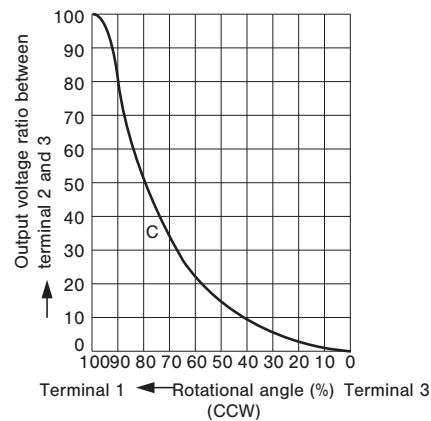

Fig.2

### ● Solderability

This is a wetting evaluation test to find out how much new solder cover the terminals dipped in the soldering bath, and to confirm the proper fillet formation in the soldering process.

### ● Pull-off strength

This test is to evaluate adherence strength of a SMD component soldered to the printed circuit board against peel off strength.

#### Test condition

Pressure: 5 N

Holding time: 10 s

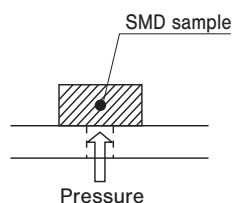

### ● Resolution

For cermet trimmer potentiometers this is essentially infinite.

### ● Effective electrical angle (Effective electrical turn)

The rotation angle (or number of turns of the shaft) within which the output voltage actually changes.



# GLOSSARY (CERMET TRIMMERS)

## TRIMMER POTENTIOMETERS

---

### ● CW, CCW

These are abbreviations for clockwise (CW) and counter clockwise (CCW).

### ● EIAJ STD

Standards of Electronic Industries Association of Japan

### ● JIS

Japanese Industrial Standards

### ● SMD (Surface Mount Device)

As electronics equipment becomes more miniaturized, needs for miniaturization of electronics components have increased. Further, surface mounting technology has emerged to increase the density of components mounted on circuit boards. SMD have been developed in response to this trend. This has allowed automation of soldering and mounting processes.

The characteristics required of SMD trimmer potentiometers are shown below:

- High heat resistance
- Sealed structure
- Compatible for automatic mounting

# APPLICATIONS

## TRIMMER POTENTIOMETERS

---

### 《Communications equipment》

- Exchangers
- Facsimile
- Assorted wireless equipment
- MUX

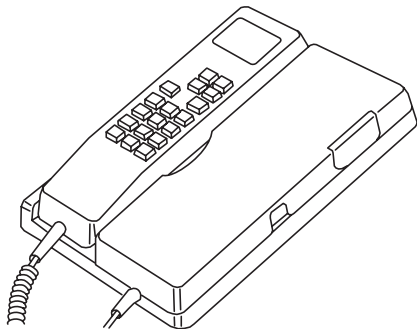

### 《Broadcasting equipment》

- Video cameras for professional use
- Color monitors
- VTR equipment

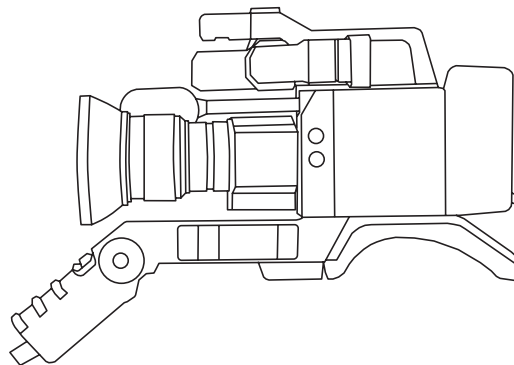

### 《Power supply equipment》

- Switching power supplies
- DC electrical power source equipment
- Assorted power supply circuits

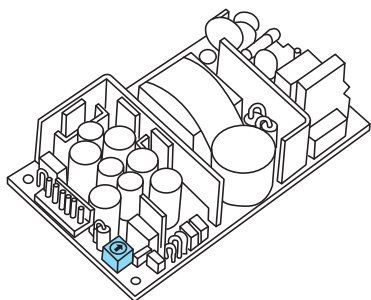

### 《Sensor devices》

- Photo electric sensors
- Pressure sensors
- Encoders
- Magnetic sensors

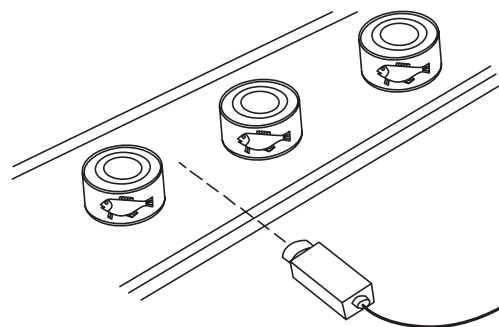

### 《Computer and peripherals》

- Laser beam printers
- Memory equipment
- Computer displays
- EMS boards
- CAD, WS

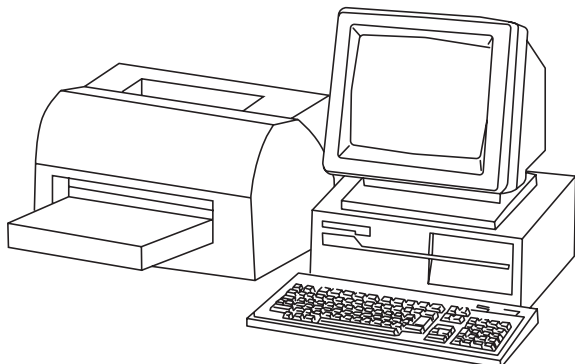

### 《Medical equipment》

- X-ray diagnosis equipment
- Ultrasonic diagnosis equipment
- Computed tomography
- Hematology analyzers
- Infusion instruments
- Telemetering systems

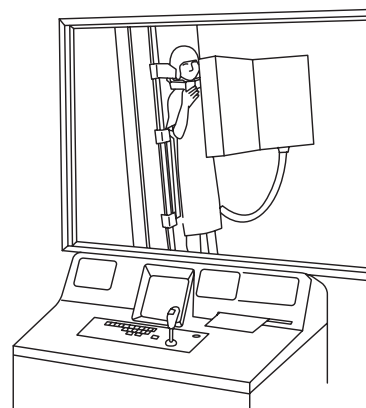

# PACKAGING

## TRIMMER POTENTIOMETERS

### ■ BULK PACKAGING SPECIFICATIONS IN PLASTIC BAGS & BOXES <Series of cermet trimmers in common>

Series name	Product shape	Maximum Q'ty/bag	Small packing box		
			Maximum Q'ty/small packing box	※ 1 W × H × D (mm) Dimensions	Gross weight(g)
ST-2	A	100	500	60 × 70 × 60	Approx.34.4
ST-32	EA, EB	100	500	60 × 70 × 60	Approx.38
	EG, EH				Approx.68
ST-4/42	EA, EB, EC, ED, EF	100	500	60 × 70 × 60	Approx.72
	EG, EH				Approx.130
ST-5	EW, EX, EP, ER	50	200	60 × 70 × 60	Approx.89
ST-7	EA, EB	50	200	60 × 70 × 60	Approx.67
SM-3/31	A, B, W	50	200	60 × 70 × 60	Approx.30
SM-42/43	A, B, W, X	50	200	60 × 70 × 60	Approx.47
RJ-4	EW	50	200	60 × 70 × 60	Approx.66
	EWS				Approx.85
CT-6	EP, EW, EV, ER	50	200	60 × 70 × 60	Approx.120
	ES, EX, EH, EN				Approx.148
	EF				Approx.107
FT-63	EP, EV	100	1000	60 × 145 × 155	Approx.570
	ES, EH, EX, EN				Approx.712
RJ-6	P, W	50	200	60 × 70 × 60	Approx.133
	S, X				Approx.176
	F				Approx.116
RJ-13	P	50	100	60 × 70 × 60	Approx.202
	B				Approx.294
	PR	25	50		Approx.123
	S				Approx.144
	SR				Approx.155
TM-7	EP, EW	50	200	60 × 70 × 60	Approx.118
	ES, EX				Approx.155
RJ-5	EW, EX, EP	50	200	60 × 70 × 60	Approx.90
CT-20	EP, EX	50	100	60 × 70 × 60	Approx.122
	EPB	25	50		Approx.200
CT-94	EP	50	100	60 × 70 × 60	Approx.107
	EW, EX, EY, EZ				Approx.110
CT-9	EP	50	100	60 × 70 × 60	Approx.107
	EW, EX				Approx.110
RJ-9	P, W, X	50	100	60 × 70 × 60	Approx.99

※ 1 Tolerance ± 2

# PACKAGING

## TRIMMER POTENTIOMETERS

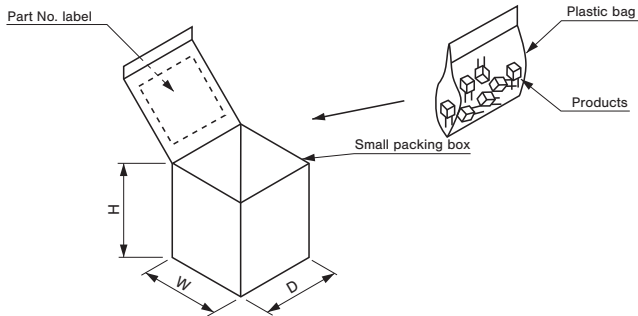

### Part No. label

Type	
Spec	
Quantity	
LOT No	
Date code	
MADE IN XXX	2D barcode
□□□□ (RoHS)	
<b>NIDEC COMPONENTS</b>	

### PACKAGING SPECIFICATIONS FOR TAPING TYPE (PLASTIC REEL) <Series of cermet trimmers in common>

Series name	Product shape	Q'ty/reel	Reel box		
			Maximum Q'ty/reel box	※ 1 W × H × D (mm) Dimensions	Gross weight(g)
ST-2	TA	500	1000	185 × 36 × 185	Approx.179
ST-32	ETA, ETB, ETD	500	2000	185 × 69 × 185	Approx.420
	ETG, ETH		500	260 × 20 × 260	Approx.277
ST-4/42	ETA, ETB, ETD	500	2000	185 × 69 × 185	Approx.563
	ETG, ETH		500	260 × 20 × 260	Approx.378
ST-5	ETP, ETR	500	500	260 × 24 × 260	Approx.477
	ETW, ETX			335 × 24 × 335	Approx.618
ST-7	ETA, ETB	500	500	260 × 24 × 260	Approx.429
SM-3/31	TA, TB, TW	500	2000	185 × 69 × 185	Approx.527
SM-42/43	TW	250	1000	185 × 46 × 188	Approx.544.4
	TX	250	1000		Approx.544.4
	TA, TB	500	1000	185 × 36 × 185	Approx.344

Note) Material of reel : Plastic (Polystyrene)

※ 1 Tolerance ± 10

**ST-2, ST-32ETA, ST-32ETB, ST-4/42ETA, ST-4ETB, SM-3/31, SM-42/43 reel box**

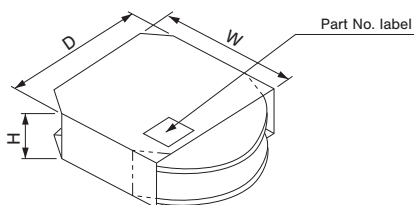

**ST-32ETG, ST-32ETH, ST-4/42ETG, ST-4/42ETH, ST-5ETP/ETR/ETW/ETX, ST-7ETA/ETB reel box**

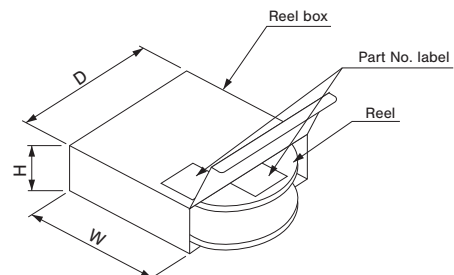

# PACKAGING

## TRIMMER POTENTIOMETERS

### Part No. label

Type	
Spec	
Quantity	
LOT No	
Date code	
MADE IN XXX	2D barcode
□□□□ (RoHS)	
<b>NIDEC COMPONENTS</b>	

### ■ PACKAGING SPECIFICATIONS FOR MAGAZINE TYPE <Series of cermet trimmers in common>

Series name	Product shape	Q'ty/stick	Magazine box		
			Maximum Q'ty/magazine box	※ 1 Dimensions W × H × D (mm)	Gross weight(g)
ST-5	EMW, EMX, EMP, EMR	50	2000	385 × 55 × 70	Approx.1570
CT-6	EMP	75	3000	610 × 55 × 145	Approx.4980
	EMS				Approx.5810

※ 1 Tolerance ± 5

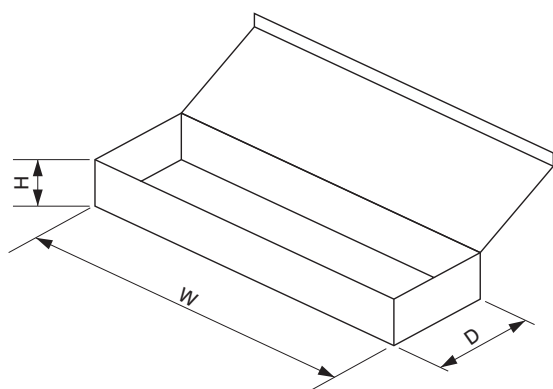

### Part No. label

Type	
Spec	
Quantity	
LOT No	
Date code	
MADE IN XXX	2D barcode
□□□□ (RoHS)	
<b>NIDEC COMPONENTS</b>	

# MARKING

## TRIMMER POTENTIOMETERS

### <Series of cermet trimmers in common>

#### ■ Marking

Production date code and resistance code are exhibited on each product as follows.

The model that this marking method is applicable : ST-32

- Lead-free soldering

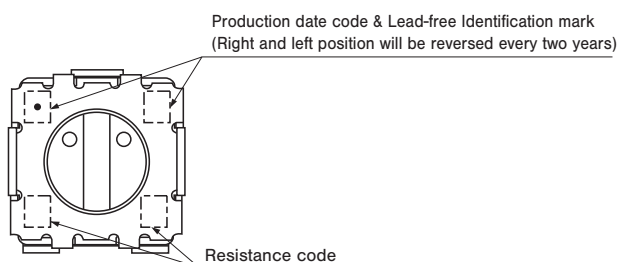

#### Resistance code

Nominal resistance values (Ω)	Code	Nominal resistance values (Ω)	Code
10	11	10 k	14
20	21	20 k	24
50	51	30 k	34
100	12	50 k	54
200	22	100 k	15
300	32	200 k	25
500	52	500 k	55
1 k	13	1 M	16
2 k	23	2 M	26
3 k	33	—	—
5 k	53	—	—

In principle, two digits are used.  
The first digit represents significant digit of ohm unit while the second digit represents a number of zeros following the significant figure.

#### Production date code

Stamping position	Year			
	Upper right	Upper left		Upper right
Month	1999 2003 2007	2000 2004 2008	2001 2005 2009	2002 2006 2010
1	A	N	A	N
2	B	P	B	P
3	C	Q	C	Q
4	D	R	D	R
5	E	S	E	S
6	F	T	F	T
7	G	U	G	U
8	H	V	H	V
9	J	W	J	W
10	K	X	K	X
11	L	Y	L	Y
12	M	Z	M	Z

In principle, Alphabet capitals per the table are used, commencing with January of a 2005 as A in order. The same arrangement will be repeated after 48 months or 4 years.

# MARKING

## TRIMMER POTENTIOMETERS

### <Series of cermet trimmers in common>

#### Example

- Lead-free soldering

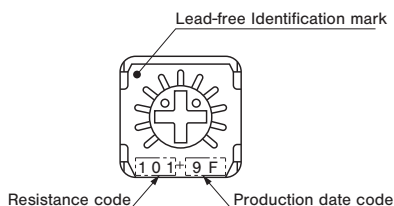

### The models that this marking method is applicable :

ST-4/42 ST-5 ST-7 SM-3/31 SM-42/43  
 RJ-4 CT-6 FT-63 RJ-6 RJ-13 TM-7  
 RJ-5 CT-20 CT-94 CT-9 RJ-9

#### Note:

- Date code marking position is per outline DWG of each model.
- Nominal resistance differs in each model. Please see the chart for each model.

### Resistance code

Nominal resistance values (Ω)	Code	Nominal resistance values (Ω)	Code
10	100	• 10 k	103
20	200	• 20 k	203
—	—	25 k	253
50	500	• 50 k	503
• 100	101	• 100 k	104
• 200	201	• 200 k	204
—	—	250 k	254
• 500	501	• 500 k	504
• 1 k	102	• 1 M	105
• 2 k	202	2 M	205
• 5 k	502	5 M	505

In principle, 3 digits are used. The first and second digits represent significant figures of ohm unit while the last digit represents a number of zeros following the significant figures.

### Production date code

Year	Code	Month	Code
2011	1	1	A
2012	2	2	B
2013	3	3	C
2014	4	4	D
2015	5	5	E
2016	6	6	F
2017	7	7	G
2018	8	8	H
2019	9	9	J
2020	0	10	Y
2021	1	11	L
...	...	12	M

Date code, in principle, consists of one digit and one capital letter. Per the above table, the digit represents the year, while the capital letter does the month.

### <Marking of ST-2 series>

Resistance values marked “•” on the list of Resistance code are available to manufacture.

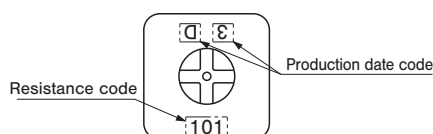

# ENVIRONMENTAL CHARACTERISTICS

## TRIMMER POTENTIOMETERS

### <Cermet trimmer: CT-6 series>

#### 1. Resistance temperature characteristics

Related standard: MIL-STD-202, method 304

Samples are kept at the ambient temperature of 25°C, -15°C, -55 °C, 25°C, 65°C and 120°C respectively for 30 to 45 minutes in a temperature chamber, and the total resistance measurement is made at each temperature. Then, the temperature coefficient referred to a reference temperature of 25°C is computed by the following formula.

$$TCR \left( 10^{-6} / ^\circ C \right) = \frac{R2-R1}{R1 \times (T2-T1)} \times 10^6$$

- R1 : Resistance value at reference temperature of 25°C
- R2 : Resistance value at test temperature
- T1 : The reference temperature
- T2 : The test temperature

The computation of the T.C.R. at the temperatures below zero (-15°C & -55°C) is to be made using the resistance value measured initially at 25°C as a reference, and that for 65°C and 120°C is to be made using the resistance value measured in the middle at 25°C as a reference.

#### <Specifications>

TCR: ±100 10<sup>-6</sup>/°C maximum (50 Ω ~ 2 MΩ)  
 ±250 10<sup>-6</sup>/°C maximum (10 Ω , 20 Ω )

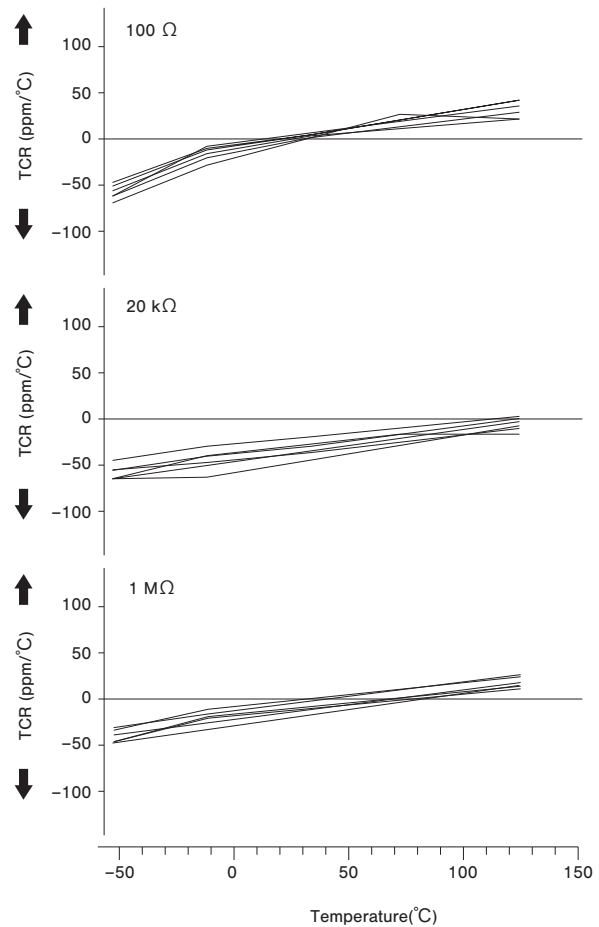



# ENVIRONMENTAL CHARACTERISTICS

## TRIMMER POTENTIOMETERS

### <Cermet trimmer: CT-6 series>

#### 2. Rotational life

Related standard: MIL-R-22097 4.6.18

The rotor shaft continuously cycled through not less than 90% of the actual effective electrical travel under no load, for a total of 200 cycles. After this, the samples are checked for a change in the total resistance value and evidence for mechanical damage.

##### <Specifications>

$\Delta R/R$ : Change in total resistance

$$\Delta R/R \leq \pm(2\% + 3\%)$$

There shall be no mechanical damage.

#### 3. High temperature exposure

Related standard: MIL-R-22097 4.6.17

Samples are exposed to an ambient temperature of 120°C in a temperature chamber for a period of 250 hours. Then, the samples are checked for a change in the total resistance value and setting stability.

##### <Specifications>

$\Delta R/R$ : Change in total resistance

$$\Delta R/R \leq \pm 3\%$$

S.S.: Setting stability

$$S.S. \leq \pm 2\%$$

R<sub>13</sub>: The resistance between terminal 1 and terminal 3

R<sub>12</sub>: The resistance between terminal 1 and terminal 2

R<sub>23</sub>: The resistance between terminal 2 and terminal 3

R<sub>c</sub>: Contact resistance

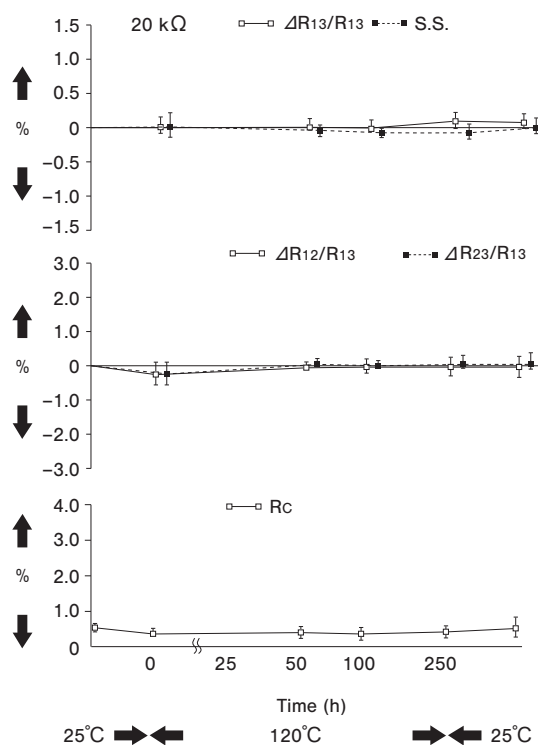
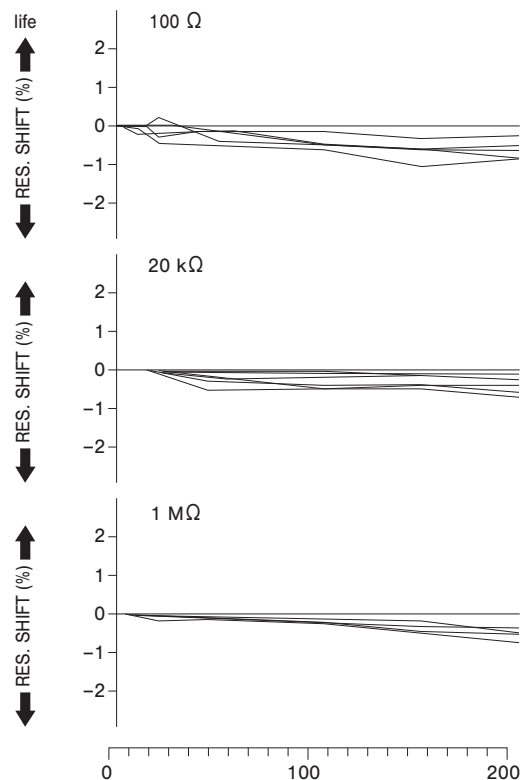

# ENVIRONMENTAL CHARACTERISTICS

## TRIMMER POTENTIOMETERS

### <Cermet trimmer: ST-4 series>

#### 1. Thermal shock

Related standards: MIL-R-22097 4.6.8  
MIL-STD-202, method 107, condition B

Samples are subjected to the following temperature cycle for 5 times and checked for a change in the total resistance value, setting stability, electrical discontinuity and mechanical damage.

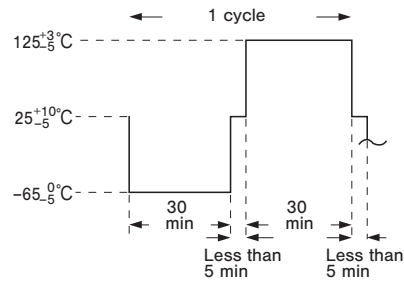

#### [Change in total resistance value] Specification: $\Delta R/R \leq \pm 2\%$

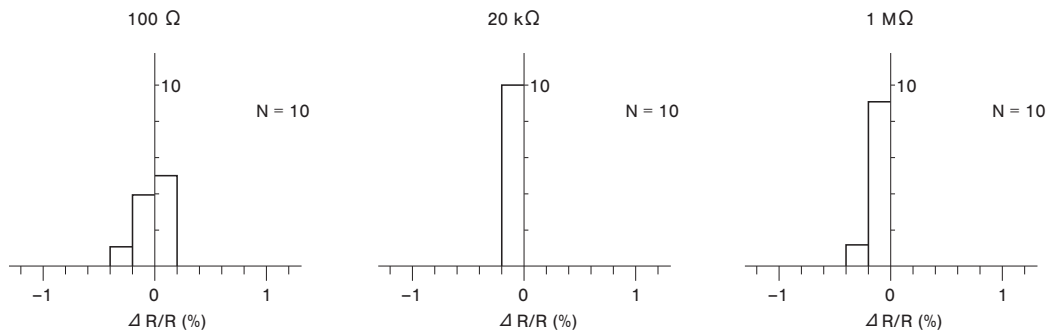

#### [Setting stability] Specification: S.S. $\leq \pm 1\%$

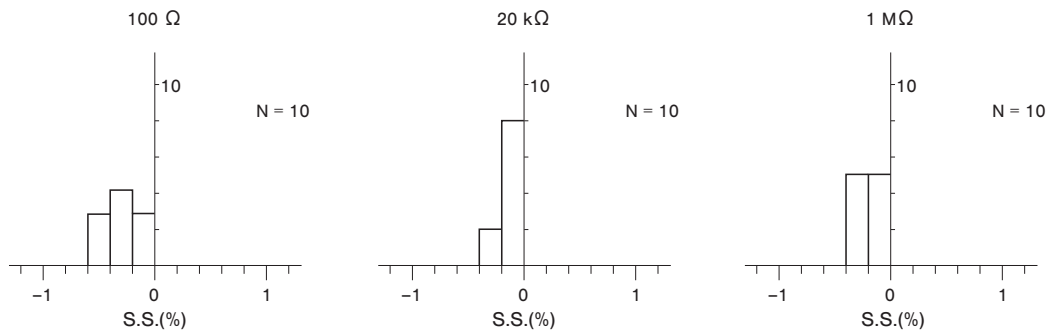

$\Delta R/R$  (%) = Change in total resistance value

S.S. (%) = Setting stability

# ENVIRONMENTAL CHARACTERISTICS

## TRIMMER POTENTIOMETERS

### <Cermet trimmer: ST-4 series>

#### 2. Soldering heat resistance

The trimmer is immersed in a pot of molten solder at a temperature of  $260_{-5}^0$  °C for period of 10 seconds, and checked for a change in the total resistance value and evidence of mechanical damage.

[Change in total resistance value] Specification:  $\Delta R/R \leq \pm 1\%$

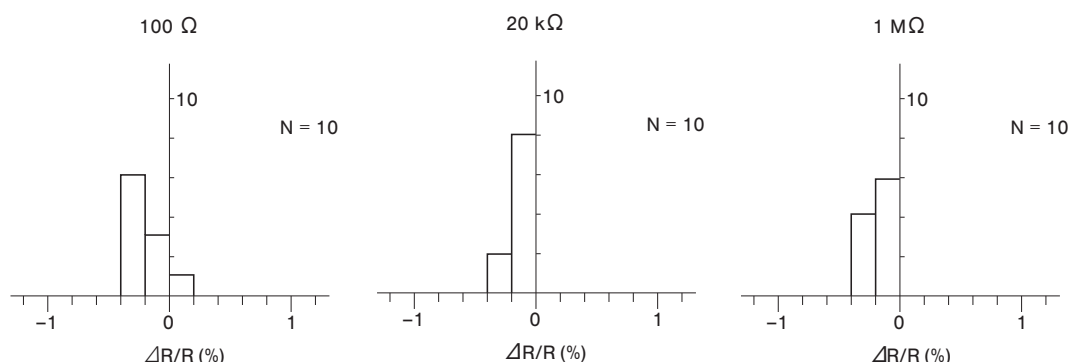

There shall be no mechanical damage.

#### 3. Load life

Related standard: MIL-R-22097 4.6.15  
MIL-STD-202, method 108, condition D

DC rated working voltage is applied intermittently to the end terminals (1 and 3) of the trimmers, 1.5 hours ON and 0.5 hour OFF, for a total of 1000 hours at a test temperature of 70°C in the temperature chamber. Then, the samples are checked for a change in the total resistance value and setting stability. While the samples are in the temperature chamber, a change in the resistance value is checked at 50, 100, 250, 500, 750 and 1000 hours respectively.

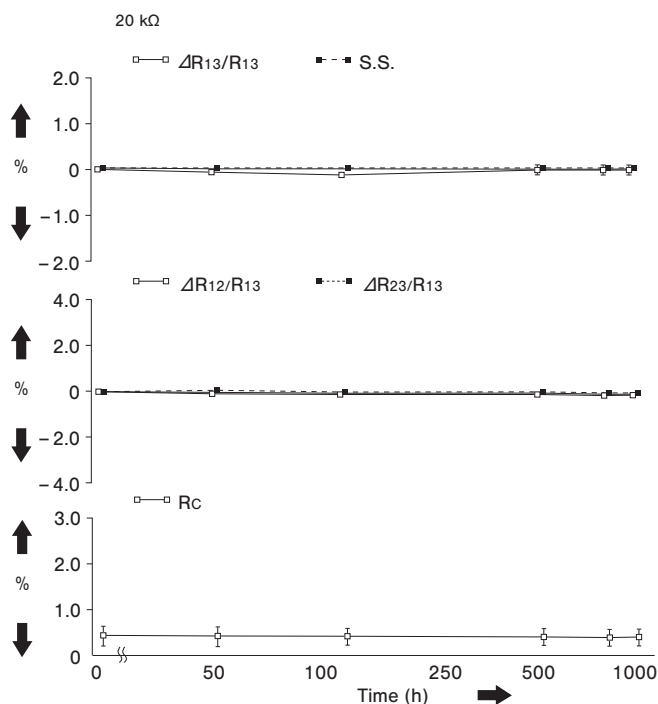

#### <Specifications>

$\Delta R/R$  : Change in total resistance

$$\Delta R/R \leq \pm 3\%$$

S.S. : Setting stability

$$S.S. \leq \pm 1\%$$

R13 : The resistance between terminal 1 and terminal 3

R12 : The resistance between terminal 1 and terminal 2

R23 : The resistance between terminal 2 and terminal 3

Rc : Contact resistance

# HANDLING NOTES

## TRIMMER POTENTIOMETERS

---

### <Series of cermet trimmers in common>

#### 1. Notes for storage

Careful attention must be paid when the components are stored.

Environmental temperature, humidity, etc. might affect the solderability of the terminals and the function of the package. Listed below are notes to be observed.

- Under extremely high temperature and humid conditions, the quality decay of the package materials will be accelerated. It is recommended the components are stored in the room at the temperature below 25 °C and with the relative humidity below 75 %.
- The environmental air must be free from corrosive gases such as sulphide gas.
- Exposure to the direct sunlight and dust must be avoided.
- Handle carefully to avoid deformation of terminals.
- Please use the potentiometers within one year from the delivery.
- Please do not open the smallest unit of package before use.

#### 3. Terminal layout

With all our trimmer potentiometers, the resistance value between the terminal No.1 and 2 increases when the rotor or the shaft is turned in CW direction.

However, as there are 2 different pin terminal layouts depending on the series of trimmer potentiometers as shown below, the terminal layout should be noted when using.

- 1) Terminal No.1 is located at the CCW (left) end;  
RJ series (RJ-4, RJ-5, RJ-6, RJ-9 and RJ-13)  
TM-7  
CT series (CT-6, CT-94, CT-9 and CT-20)  
ST-2, ST-5, ST-7, SM-31/32, SM-42/43 and FT-63
- 2) Terminal No.3 is located at the CCW (left) end;  
ST-32 and ST-4

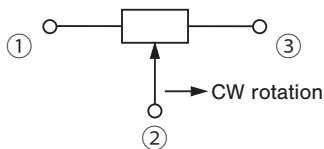

#### 2. Sealed construction

The structure of our trimmers is designed to withstand flux and cleaning solvents used in the soldering and cleaning process.

This sealed structure is also effective for dust and moisture as well, but its capability is not limitless due to inside moving parts.

The following are not recommended.

- Environmental air with sulphide gas, corrosive gas or reducing gas
- Rapid cooling of solvents
- Long time damping into solvents (especially at high temperature)
- Environmental air with high humidity

# HANDLING NOTES

## TRIMMER POTENTIOMETERS

### <Series of cermet trimmers in common>

#### 4. Power rating

The power rating should be derated as per Fig. 1 when an ambient temperature exceeds 70°C (85°C). Trimmer potentiometers can be used as voltage regulators as shown in Fig. 2 (A) or as current regulators (rheostats) as shown in (B). For cermet trimmer potentiometers, use for voltage regulation will result in more stable performance.

For use as a current regulator as shown in Fig. 2 (B), or when current flow is high, reduce the power depending on the position of the wiper as shown in Fig.3.

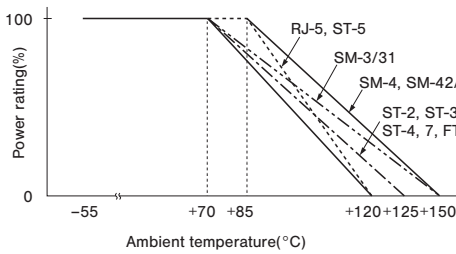

[Fig.1]

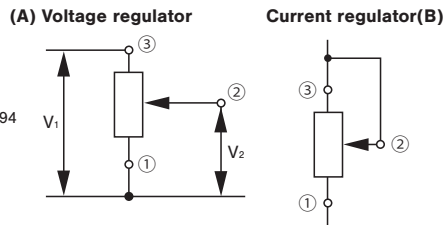

[Fig.2]

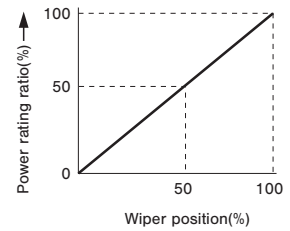

[Fig.3]

#### 5. Soldering conditions

##### 1) SMD type in common

##### ● Infrared reflow soldering

The temperature profile shown below is recommended for reflow soldering, but it is subject to soldering conditions, such as soldering temperature, preheat temperature, specific gravity of flux, belt speed etc. Please make sure before use if your soldering conditions are appropriate.

In case of infrared heater, the absorption rate varies depending on color, material etc of the object. The extent of heating varies accordingly, which please note.

#### Reflow soldering

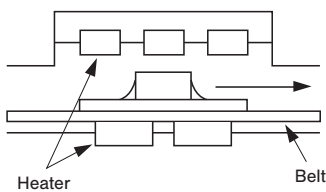

#### Recommended profile for lead-free soldering

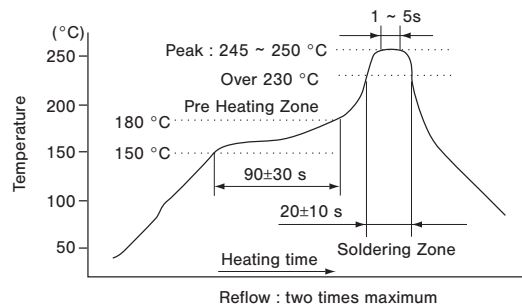

# HANDLING NOTES

## TRIMMER POTENTIOMETERS

### <Series of cermet trimmers in common>

#### ● Flow soldering

The temperature profile shown below is recommendable in the flow soldering process, but it may not be suitable in case of high mounting density or depending on equipment.

#### Flow soldering

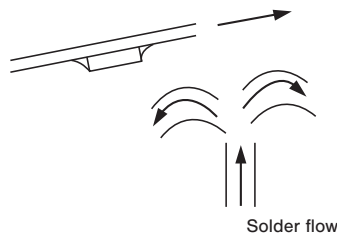

#### Recommended profile for lead-free soldering

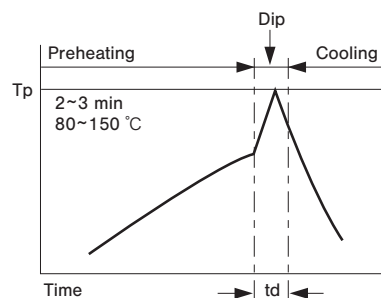

#### ● Manual soldering

Soldering shall be done at 350°C(lead-free for 3 seconds [max.].) The iron tip must not be touched to the housing resin, but only to the terminal.

#### ● Flux

Depending on flux to be applied, markings may, though a rare case, disappear or fade out at soldering. Please make sure before its use.

#### 2) Through hole type in common

Soldering shall be done at 245 ~ 260°C for 3 ~ 5 seconds per one time. The total time of application must not exceed 10 seconds.

The product itself shall be away from the soldering bath. Otherwise, the product components may be distorted by the heat, which may cause performance deterioration.

#### 3) Multiturn adjustment models in common

Avoid soldering or applying the heat to the trimmer potentiometer when the wiper is positioned at either end of the mechanical travel where the stress is applied to the clutch spring.

If the heat is applied to the trimmer potentiometers at such positions, the clutch spring will be weakened due to thermal fatigue of the plastic material, causing the malfunction in rotation.

# HANDLING NOTES

## TRIMMER POTENTIOMETERS

### <Series of cermet trimmers in common>

#### 6. Cleaning

Cleaning subsequent to soldering must be done after components are cooled to the room temperature below 30°C. The solvent might penetrate into the inside of trimmer if they are immersed in it without being cooled.

Also, confirmation of stability of trimmer temperature must be done before going to next process because trimmers themselves may be rapidly cooled by the heat of evaporation when cleaning solvents evaporate. the products can not apply for special cleaning such as vacuum (decompression) cleaning. Do not use special clearing.

#### 8. Cleaning method

Main cleaning methods for cermet trimmers are shown in the table below. When the cleaning time is too long, the rotational torque can vary due to the expansion of O-ring. After cleaning, dry sufficiently before adjustment.

For vacuum (decompression) cleaning, be caution do not mix 2 different liquids.

#### 7. Cleaning solvents

Cermet trimmers are can be washed. Chlorofluoro carbon (CFC) and 1, 1, 1-Trichloroethane is Ozone layer destroying substance and the International Agreement for their total abolishment has been made.

We recommend the following as substitute for them.

**CLEAN THROUGH 750HS** [Kao Corporation]  
**PINE ALPHA ST-100S** [ARAKAWA CHEMICAL INDUSTRIES, LTD.]

#### Water cleaning Alcohol

※ It is not suitable for hydrocarbon series clearliquid.

### Cleaning method

○ Possible    × : Not possible

Method	Dipping	Ultrasonic	Vapor	Showering	Brushing
Applicability	○	○	○	○	×
Time	Approx. 2 minute				—
Note	—				Marking ink will be removed

# HANDLING NOTES

## TRIMMER POTENTIOMETERS

### <Series of cermet trimmers in common>

#### 9. Combination of cleaning methods

Possible combination of cleaning methods for trimmers is shown below. In this case, the cleaning time should be approximately 1 minute respectively.

Trimmers themselves may be rapidly cooled in the latent heat of evaporation and may inhale the cleaning solvent in case of internal air shrinkage of trimmer.

Next cleaning should be waited until confirmation of enough stability of trimmer temperature after the first cleaning.

- Dipping (1 minute) + Vapor (1 minute)
- Ultrasonic (1 minute) + Dipping (1 minute)
- Showering (1 minute) + Vapor (1 minute)

※ The above can change depending on conditions, and thus check before actual cleaning.

#### 10. Coating and potting

If the trimmer potentiometer is coated or potted, the movable parts (rotor and shaft) may lock, making readjustment difficult.

Further, if coating or potting is made, make sure that the hardening temperature does not exceed 120°C.

Do not use coating or potting material containing the following substances:

- Methylene chloride
- Thinner
- Acetone
- Xylene

#### 11. Tamper proof seal

For models with the resistance value and production date code printed on the adjustment surface perform tamper proof seal avoiding the part. (See the sketch below.)

A minimum amount of tamper proof seal material with high viscosity should be applied since readjustment may become difficult after tamper proof seal is performed.

#### Tamper proof seal



Small amount is applied away from driver groove and printed part.

Single turn  
(CT-6)



Printed area can not be read.

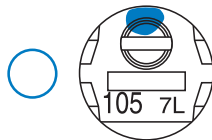

Multi turn  
(TM-7)

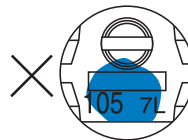



# HANDLING NOTES

## TRIMMER POTENTIOMETERS

### <Series of cermet trimmers in common>

#### 12. Circuit board hole diameter

##### <Reference values>

- RJ-4, RJ-5, RJ-6 .....  $\varnothing$  0.7 ~  $\varnothing$  0.9 mm
- CT-6, FT-63, TM-7 .....  $\varnothing$  0.75 ~  $\varnothing$  0.95 mm
- RJ-9, CT-94, CT-9, CT-20 .....  $\varnothing$  0.8 ~  $\varnothing$  1.0 mm
- ST-4EC .....  $\varnothing$  0.9 ~  $\varnothing$  1.1 mm
- RJ-13 .....  $\varnothing$  1.0 ~  $\varnothing$  1.2 mm

※ Please note the above hole diameters are reference values.

#### 13. Screwdriver to use

For adjustment, use a screwdriver whose tip fits an adjustment slot. When a screwdriver as one with too large a grip or with too small tip is used, the rotation stopper or adjustment slot of the trimmer may be damaged.

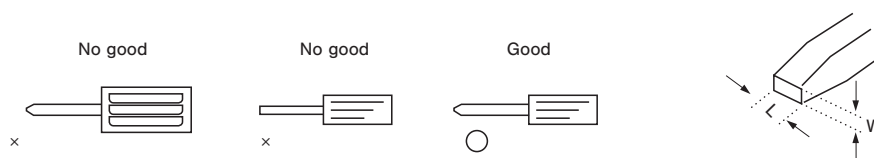

		Adjustment slot dimensions Unit : mm (W × L × D)	Adjustment driver tip thickness (Reference values) Unit : mm		
			Tip (W)	Tip thickness (L)	Grooves
Single turn	ST-2	0.35 × 1.5 × 0.3	0.3 ~ 0.35	1.4	- screwdriver
	ST-32	0.5 × 1.9 × 0.45	0.2 ~ 0.4	1.5 ~ 1.7	-, + screwdriver
	ST-42	0.6 × 2.3 × 0.5	0.3 ~ 0.5	1.6 ~ 2.0	-, + screwdriver
	ST-4			- screwdriver	
	RJ-4	0.6 × 2.5 × 0.8	0.4 ~ 0.5	1.8 ~ 2.3	-, + screwdriver
	CT-6	0.6 × 2.6 × 1.6			
	FT-63	0.7 × 3.0 × 1.6	0.3 ~ 0.4	2.6 ~ 2.9	
	RJ-6	0.5 × 2.6 × 0.8	0.5	1.8 ~ 2.3	
RJ-13	0.7 × 5.0 × 1.0	0.2 ~ 0.3	4.0		
Multiturn	SM-3/31	0.4 × 1.3 × 0.3	0.2 ~ 0.3	0.9 ~ 1.2	- screwdriver
	SM-42/43	0.56 × $\varnothing$ 1.5 × 0.5	0.2 ~ 0.4	1.2 ~ 1.4	
	ST-7	0.5 × 1.8 × 0.5	0.3 ~ 0.4	1.6 ~ 1.9	
	ST-5	0.6 × $\varnothing$ 1.6 × 0.8		1.3 ~ 1.6	
	RJ-5	0.6 × $\varnothing$ 2.5 × 0.7	0.3 ~ 0.5	1.8 ~ 2.3	
	TM-7	0.6 × $\varnothing$ 2.3 × 0.8		1.6 ~ 2.0	
	CT-94	0.6 × $\varnothing$ 2.5 × 0.8	0.3 ~ 0.5	1.8 ~ 2.3	
	CT-9			1.6 ~ 2.0	
	RJ-9			1.8 ~ 2.3	
	CT-20	0.6 × $\varnothing$ 2.5 × 0.8		1.8 ~ 2.3	

#### <Recommended screwdrivers>

- ST-32 : VESSEL Ceramic adjustment driver No.9000 (  $\ominus$  1.8 × 30)
- ST-32, ST-42 : // No.9000 (  $\oplus$  0 × 30) The driver shave off the head about 0.2 mm.
- ST-2 : ENGINEER INC., DA-54

# HANDLING NOTES

## TRIMMER POTENTIOMETERS

---

### 14. Electrical adjustment range

Avoid using trimmer with its wiper set at either CW or CCW end. The end of the electrical adjustment range for cermet trimmer potentiometers is the overlapping area where the resistor and the conductor are in direct. The resistance here changes irregularly. Use the trimmer potentiometer in the 10 % to 90 % electrical adjustment range.

### 16. Mechanical loading

The trimmer shall not be used with any mechanical load applied on the body of the trimmer.

### 15. Strength of terminals

Handle carefully; the force or bending, twisting, etc. to the terminals might be the cause of terminal break.

### 17. Caution for the use of high frequency circuit

Our trimmers are not specially designed for the use of high frequency circuit.

Please consult with our sales office or sales agent for such application.

■ **"HANDLING NOTES" is the one to prevent the accident and the performance deterioration beforehand.  
Please make consideration of it.**